

0/152-0/156

**ROMA-ITALICA-ECCELSA
ASTER-BAMBOO
CENTOTRENTA-TITIAN**

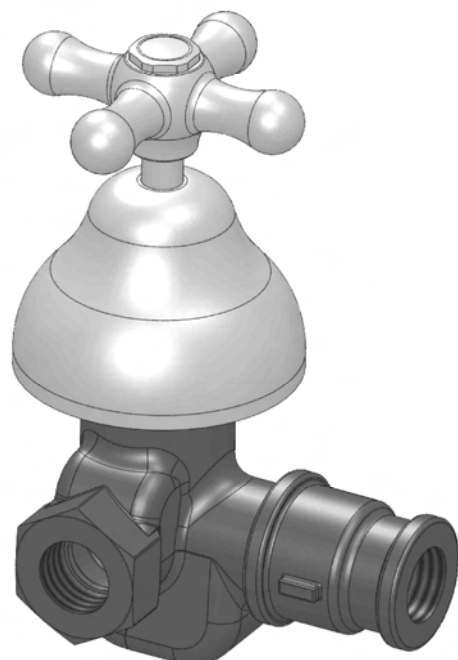

NORME GENERALI PER L'INSTALLAZIONE

- E' necessario innanzitutto assicurarsi che le tubazioni di alimentazione non contengano impurità o corpi estranei. Lasciar defluire dalle stesse quindi una certa quantità d'acqua prima di collegare il miscelatore.
- Per il corretto funzionamento del rubinetto è **assolutamente indispensabile** collegare l'entrata e l'uscita dell'acqua in modo corretto (vedi freccia)
- Non installare in presenza di pressione dell'acqua superiore a 30 bar (in questo caso è richiesto un riduttore di pressione)
- Il rubinetto può essere alimentato con acqua con una temperatura compresa tra 5° e 70° C

GENERAL RULES FOR THE INSTALLATION

- You must first make sure that the supply lines do not contain impurities or foreign bodies. Allow to drain and then some by the same amount of water before connecting the mixer
- For the correct operation of the tap is **absolutely essential** to connect the inlet and outlet water properly (see arrow)
- Do not install in the presence of water pressure above 30 bar (in this case require a pressure reducer)
- The tap can be supplied with hot water at any temperature between 5° and 70° degrees

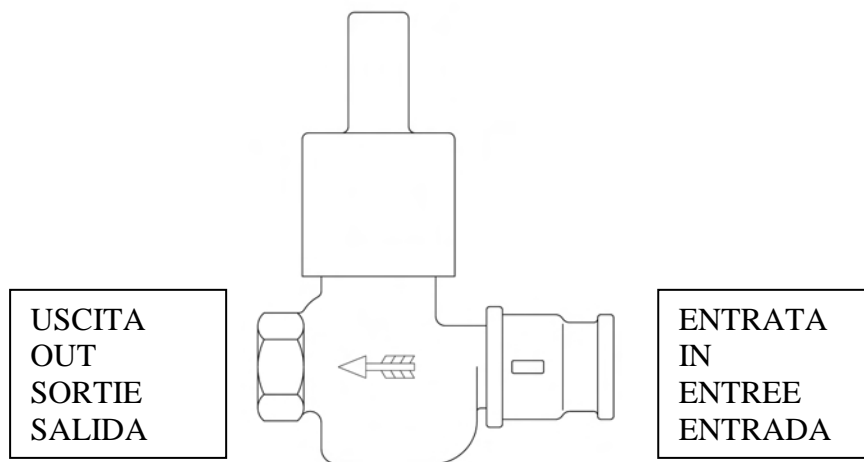

RÈGLES GÉNÉRALES POUR L'INSTALLATION

- Vous devez d'abord vous assurer que les lignes d'alimentation ne contiennent pas d'impuretés ou de corps étrangers. Laisser égoutter, puis les uns par la même quantité d'eau avant de le brancher.
- Pour le bon fonctionnement du robinet est **absolument essentiel** pour relier l'entrée et la sortie de l'eau correctement (voir flèche)
- Ne pas installer dans la présence d'eau sous pression au-dessus de 30 bar (dans ce cas besoin d'un réducteur de pression)
- Le robinet peut être alimentée avec eau chaude à une température comprise entre 5° et 70° degrés

NORMAS GENERALES PARA LA INSTALACIÓN

- Primero debe asegurarse de que las tuberías de suministro no contengan impurezas o cuerpos extraños. Dejar escurrir una cierta cantidad de agua antes de conectar el mezclador.
- Para el correcto funcionamiento de la válvula es **absolutamente esencial** para conectar la entrada y salida de agua adecuada (véase la flecha)
- No lo instale en la presencia de presión de agua por encima de 30 bar (en este caso requieren un reductor de presión)
- La válvula puede ser alimentado con agua caliente a una temperatura entre 5° y 70°

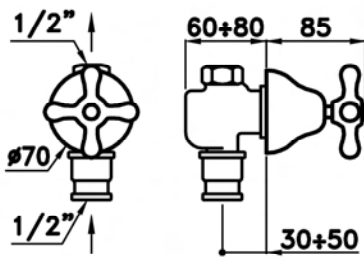

0/156 ROMA 1/2"

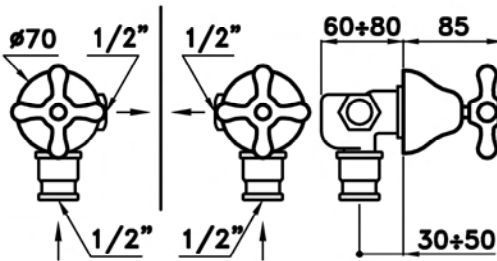

0/152 ROMA

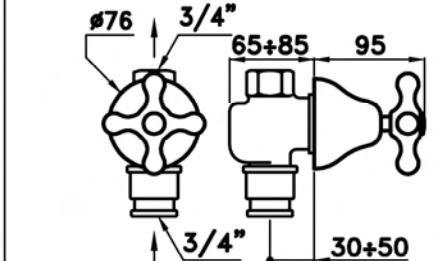

0/156 ROMA 3/4"

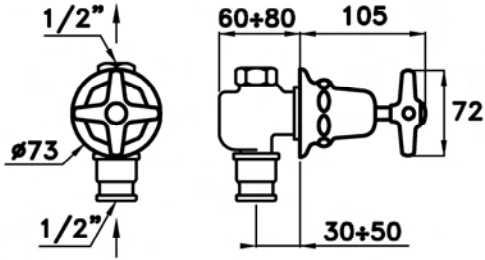

0/156 ITALICA

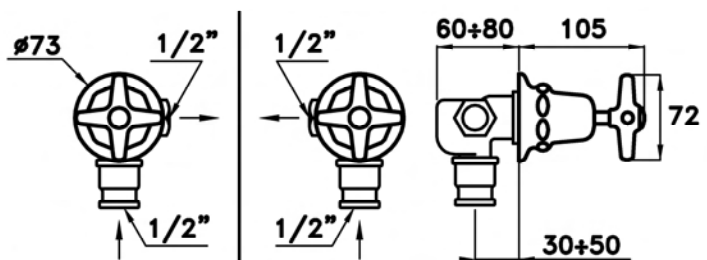

0/152 ITALICA

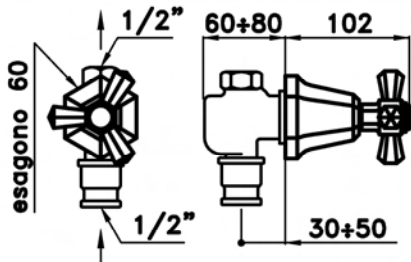

0/156 ECCELSA

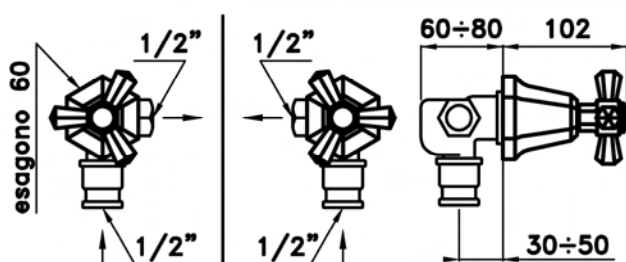

0/152 ECCELSA

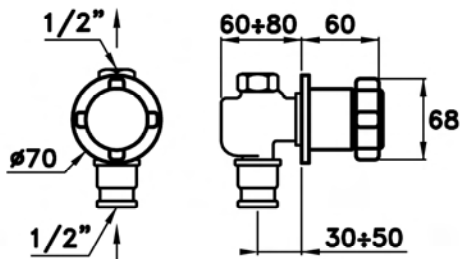

0/156 ASTER

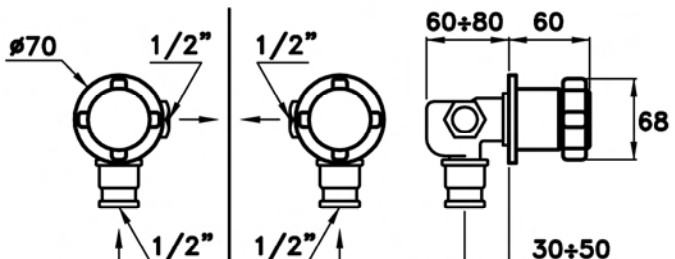

0/152 ASTER

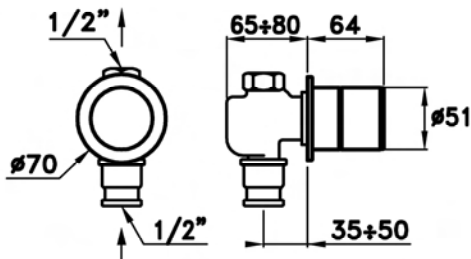

0/156 BAMBOO

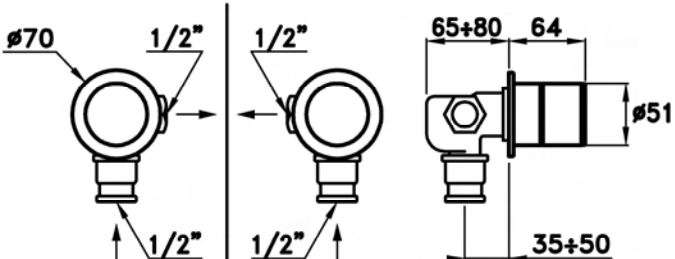

0/152 BAMBOO

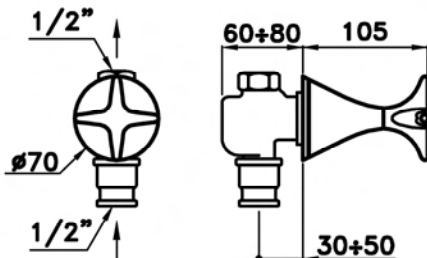

0/156 CENTOTRENTA

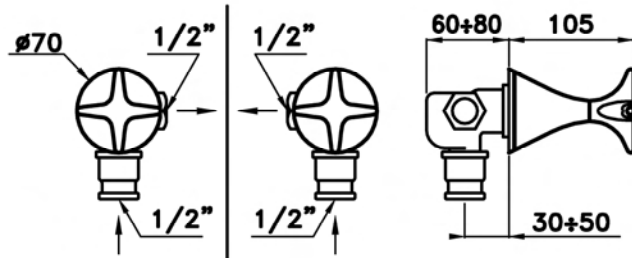

0/152 CENTOTRENTA

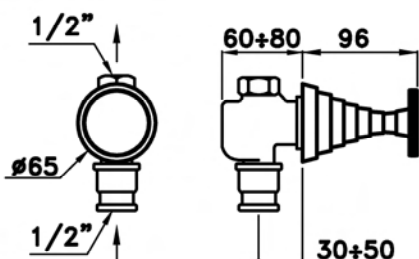

0/156 TITIAN

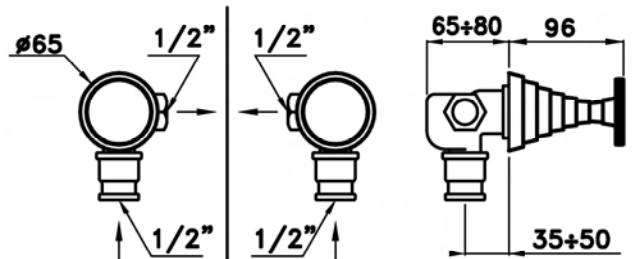

0/152 TITIAN

Per ottenere la giusta profondità d'incasso in rubinetto deve essere installato in modo che il cappuccio di copertura abbia una distanza dal filo parete compreso tra le misure indicate.

Per correggere le inevitabili differenze di profondità di incasso si procede come segue:

Togliere il cappuccio in plastica (1), allentare di mezzo giro il dado esagonale (2), avvitare o svitare il canotto (3) per fornire il regolazione desiderata, stringere a fondo il dado (2)

Sul dado (2) è presente un'indicazione del "FILO PARETE FINITA" corretto (L)

Montare le parti in finitura

To get the right depth of recessed valve must be installed so that the cap has a distance from the cover flush with the wall between the measures indicated.

To correct the inevitable differences of depth of collection proceeds as follows:

Remove the plastic cap (1), loosen the hex nut one half turn (2), screw or unscrew the sleeve (3) to provide the desired adjustment, tighten the nut (2)

The nut (2) there is an indication "FILO PARETE FINITA" correct(L)
Place the components in finishing

Pour obtenir la bonne profondeur de la vanne encastrée doit être installé de telle sorte que le bouchon a une distance de la rincer couvrir avec le mur entre les mesures indiquées.

Pour corriger les inévitables différences de profondeur de la collecte procède comme suit:

Enlever le capuchon en plastique (1), desserrer l'écrou d'un demi tour (2), visser ou dévisser la douille (3) de fournir le réglage désiré, serrer l'écrou (2)

L'écrou (2) il ya une indication de "FILO PARETE FINITA" correcte (L)

Placer les composants dans la finition

Para obtener la profundidad adecuada de la válvula de empotrar deben instalarse de manera que la tapa tiene una distancia de la tapa al ras con la pared entre las medidas indicadas.

Para corregir las inevitables diferencias de profundidad de los fondos de recogida de la siguiente manera:

Retire la tapa de plástico (1), aflojar la tuerca hexagonal de media vuelta (2), tornillo o desenroscar el casquillo (3) para proporcionar el ajuste deseado, apretar la tuerca (2)

La tuerca (2) no es una indicación de "FILO PARETE FINITA" correcta
Coloque los componentes en el acabado

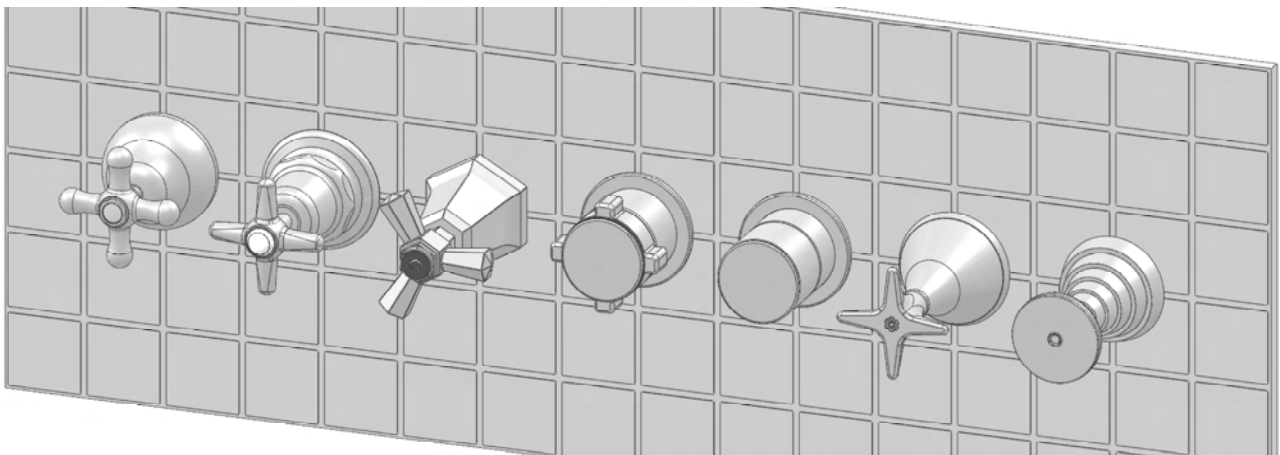
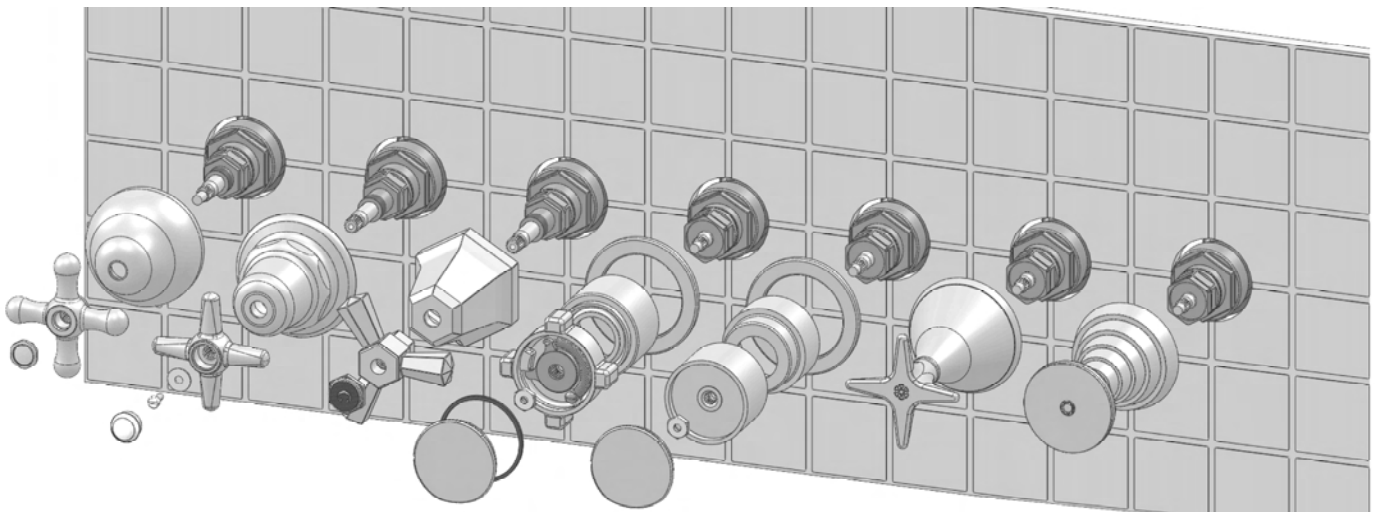
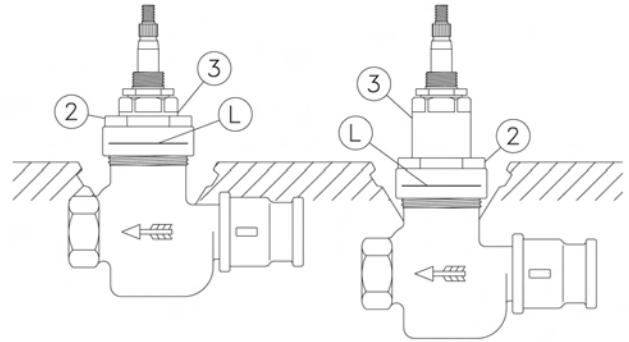
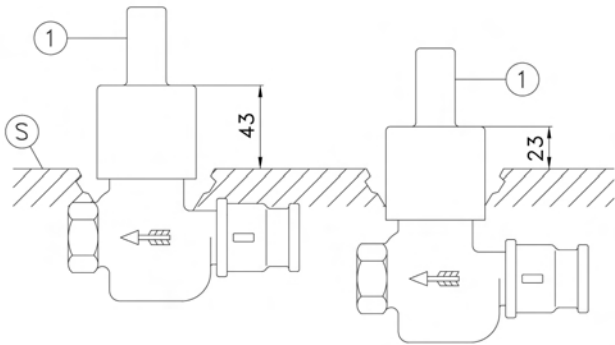

RICAMBI – SPARE PARTS – RECHANGE - REPUESTOS

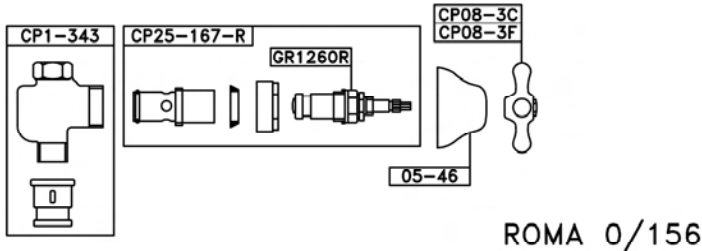

ROMA 0/156

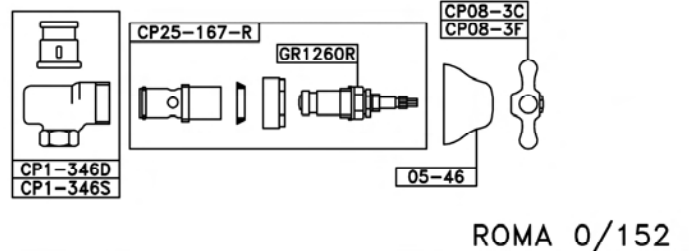

ROMA 0/152

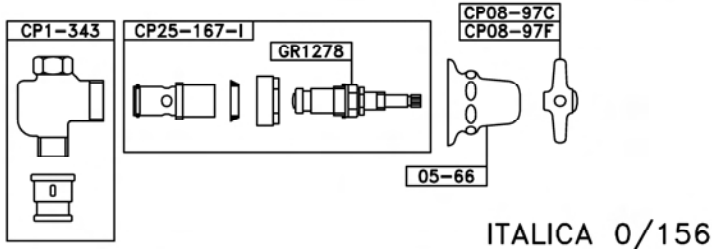

ITALICA 0/156

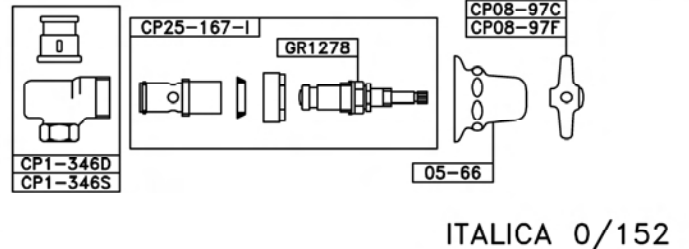

ITALICA 0/152

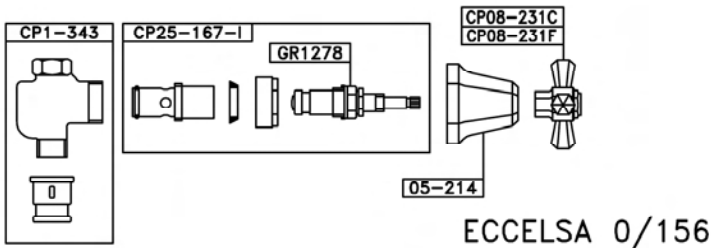

ECCELSA 0/156

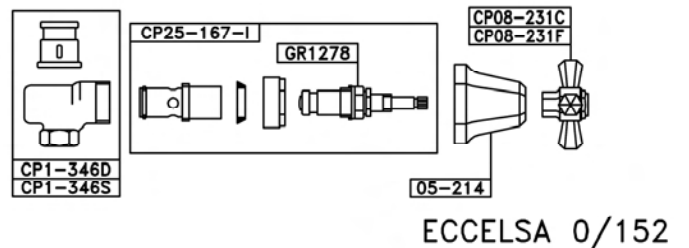

ECCELSA 0/152

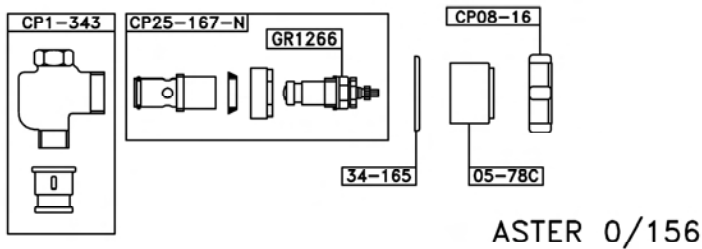

ASTER 0/156

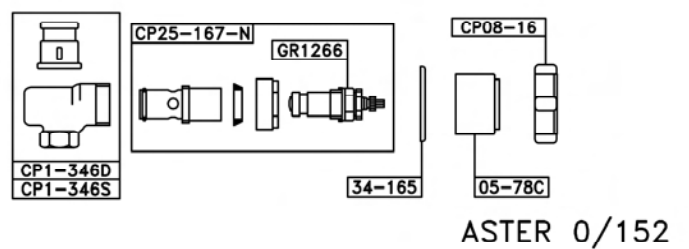

ASTER 0/152

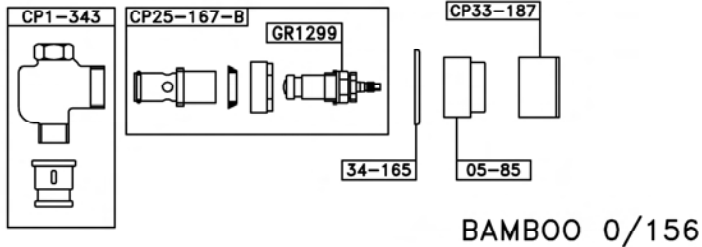

BAMBOO 0/156

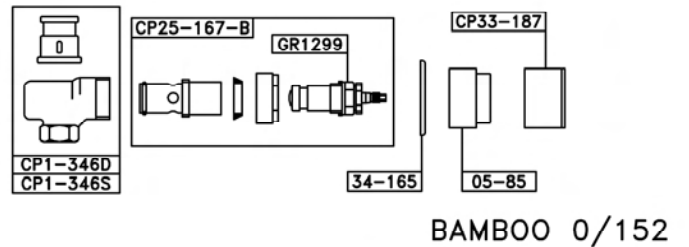

BAMBOO 0/152

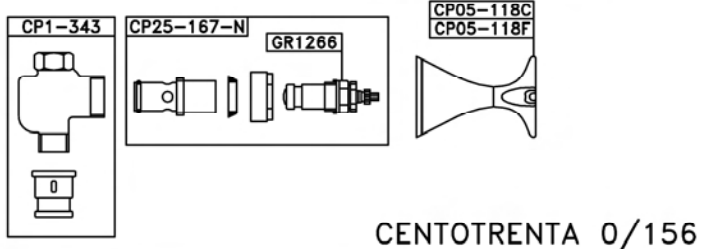

CENTOTRENTA 0/156

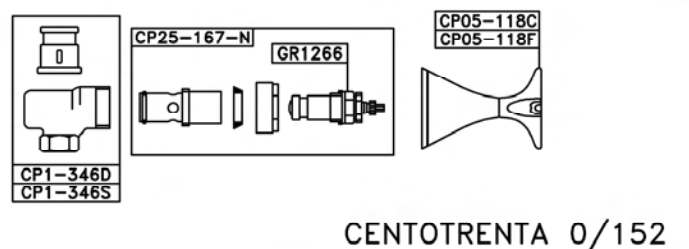

CENTOTRENTA 0/152

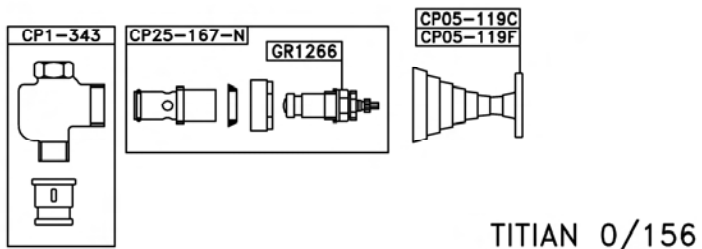

TITIAN 0/156

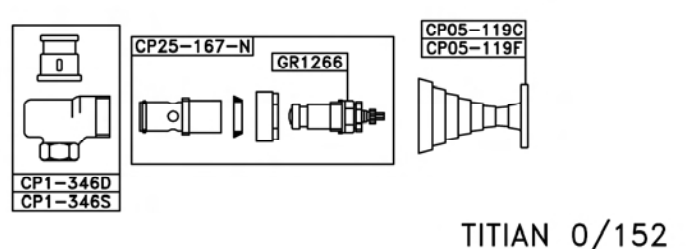

TITIAN 0/152

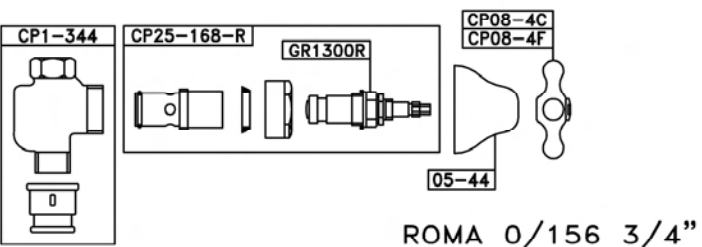

ROMA 0/156 3/4"

PROLUNGHE

	+25	+50
ROMA	GR1260RPR	GR1260RPR50
ROMA 3/4"	GR1300RPR	GR1300RPR50
ITALICA-ECCELSA	GR1278RPR	GR1278RPR50
ASTER-CENTOTRENTA-TITIAN	GR1266RPR	GR1266RPR50
BAMBOO	GR1299RPR	GR1299RPR50

Portate e pressioni - Flows and pressures

Débits et les pressions - Los flujos y presiones

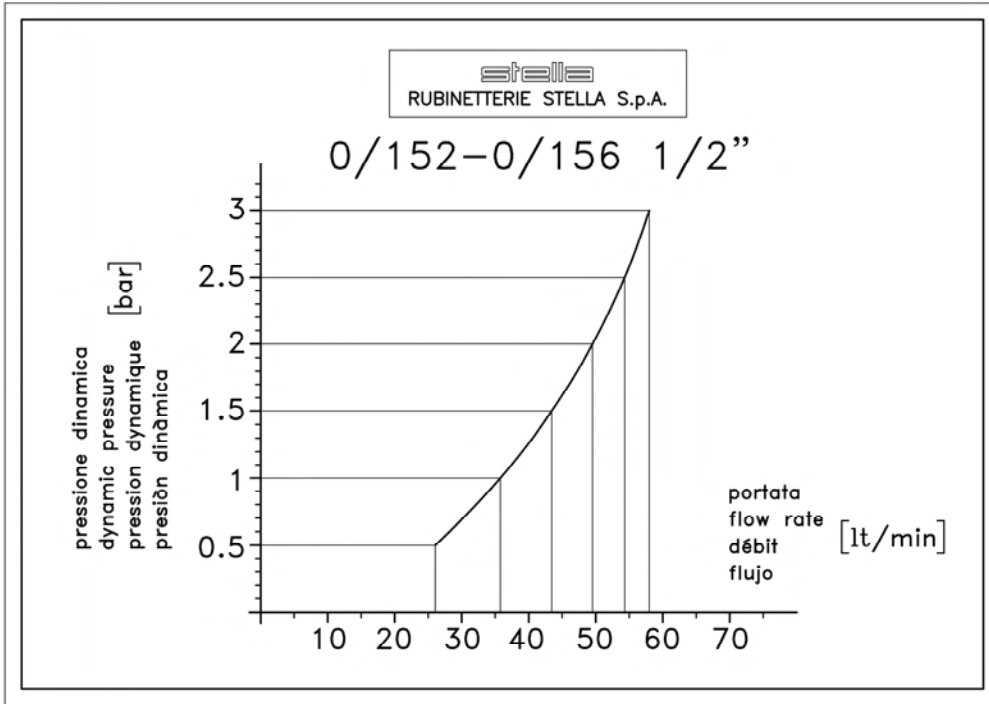

pressione dinamica dynamic pressure pression dynamique presión dinàmica (bar)	portata flow rate débit flujo (lt/min)
0.5	26
1	35.5
1.5	43.5
2	49.5
2.5	54.5
3	58

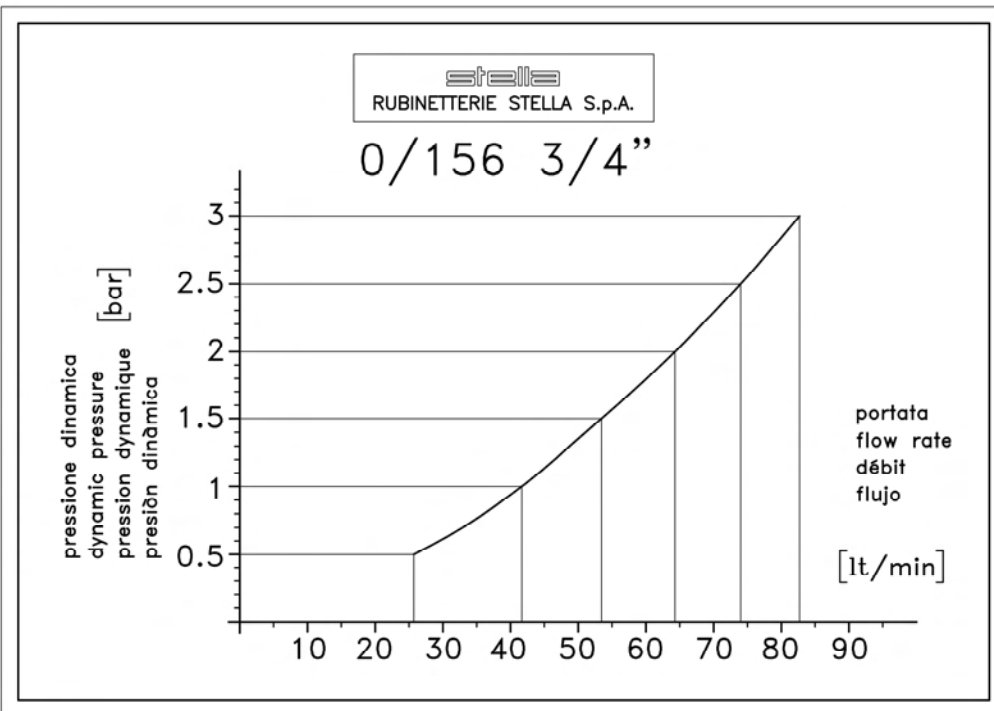

pressione dinamica dynamic pressure pression dynamique presión dinàmica (bar)	portata flow rate débit flujo (lt/min)
0.5	26
1	41.5
1.5	53.5
2	64.5
2.5	74
3	82.5

- Campo di lavoro 5°C - 70°C
- Pressione consigliata 1.5 bar
- Pressione statica max 30 bar

- Plage de travail de 5 °C - 70 °C
- Pression recommandée de 1,5 bar
- Pression maxi 30 bar

- Working range 5 °C - 70 °C
- Recommended pressure 1.5 bar
- Max pressure 30 bar

- Campo de trabajo de 5 °C - 70 °C
- Recomendaciones de presión de 1,5 bar
- Presión máxima de 30 bar

GARANZIA

Tutti i nostri prodotti sono realizzati a "regola d'arte" e sottoposti a scrupolosissimi controlli durante ogni fase del processo produttivo e la proverbiale robustezza e affidabilità che li caratterizza ci consentono di accordare una garanzia, a valere dalla data d'installazione:

- illimitata: su tutti i corpi da incasso in bronzo
- di 5 anni: su tutta la nostra produzione in finitura cromo e sugli elementi non superficiali delle rubinetterie in altra finitura
- di 2 anni: sulle parti in vista delle serie in finitura Nichel, Ottone Protetto, Argento e Oro

In applicazione della normativa europea, recepita da apposita legge italiana, la garanzia copre ogni difetto di fabbricazione (difetti di fusione, di lavorazione meccanica e di finitura) previo controllo del pezzo difettoso da parte del nostro Ufficio Tecnico.

La garanzia non copre il materiale che presenti le seguenti situazioni:

- normale usura o danni causati da eccesso di calcare nell'acqua (guarnizioni, rompigetti, fondelli di soffioni, ecc.) o dal gelo
- deterioramento delle superfici dovuto a utilizzazione di materiali per la pulizia non idonei o a pulizia delle superfici effettuata in modo non corretto senza tener conto delle nostre istruzioni
- deterioramento causato da installazione non corretta
- anomala utilizzazione della rubinetteria
- riparazioni e/o manutenzioni mal effettuate e/o utilizzazione di ricambi inadatti o non originali Stella

La garanzia si limita alla riparazione o alla sostituzione dei pezzi difettosi, da effettuarsi nel nostro stabilimento o nei centri assistenza da noi autorizzati, e non copre i costi di smontaggio, rimontaggio ne eventuali danni ai rivestimenti o ai sanitari.

RECLAMI:

Eventuali reclami di qualsiasi genere devono pervenire per lettera raccomandata entro 8 giorni dall'arrivo a destinazione della merce.

CONTESTAZIONI:

Per ogni contestazione è riconosciuta la sola competenza del Foro di Novara.

WARRANTY

All other products are superbly crafted and are subject to the most stringent tests in each stage of the production process: their celebrated sturdiness and reliability means that we are able to cover them with the following warranties as from the date of installation:

- unlimited on all recessed units in bronze
- 5-year: on all chrome-plated products and all non-surface elements of taps with other finishes
- 2-year: on exposed parts in the nickel-finish, protected brass, silver and gold-finish collections.

In accordance with European regulations, implemented by a special Italian law, the warranty cover any manufacturing defects (casting defects, mechanical processing and finishing), subject to inspection of the defective part by our Engineering Departement.

The warranty does not cover materials in the following conditions:

- normal wear or damage caused by excessive limestone in the water (washers, aerators, showerhead plates, etc.) or freezing.
- deterioration of surfaces due to the use of unsuitable cleaning products or cleaning of the surfaces carried out incorrectly and not in accordance with our instructions.
- deterioration caused by incorrect installation
- anomalous use of the taps
- repairs and/or maintenance carried out incorrectly and/or with the use of unsuitable or non-original spare parts

The warranty covers only the repair or replacement of the defective part, to be carried out in our factory or in technical assistance centres authorised by Stella. It does not cover the costs of disassembly, reinstallation or any damage caused to surface materials or to sanitary fittings.

COMPLAINTS:

Any complaint of any kind must be sent by registered letter within eight days of the arrival of the goods at destination. Should no complaint be made before such time, the products will be considered to have been accepted by the Purchaser.

REGULATIONS:

Most of our products are made in compliance with those European Union (EU), regulations that may be applicable to them. Except in the case of an explicit declaration by Rubinetterie Stella S.p.A., no guarantee is issued concerning compliance of the products with national rules and regulations – expressly including safety and accident-prevention standards in force in the country of the Purchaser – should the latter be the resident outside the EU or, more in general, in any nation that is not a member of the EU.

DISPUTES:

The Court of Novara shall be the sole court of jurisdiction for the resolution of any disputes.

GARANTIE

La garantie sur notre robinetterie couvre tout défaut de fabrication, à condition qu'elle ait été installée par des professionnels qualifiés suivant les règles de l'art, conformément à la législation en vigueur et selon nos instructions de montage.

La durée de la garantie est de 5 ans à compter de la date d'installation, à l'exception des traitements spéciaux et des revêtements autres que le chrome (2 an). La garantie ne couvre pas l'usure normale des pièces en mouvement, les conditions d'utilisation anormales, les dommages consécutifs à la nature des eaux, à l'incendie ou au gel. La garantie se limite à la réparation ou au remplacement en nos atelier du matériel reconnu défectueux. Elle ne prend pas en compte les frais de pose et de dépose ni d'éventuels dommages et intérêts, notamment pour privation de jouissance.

NORMES:

Nos robinetteries sont conformes à plusieurs Normes Européennes EN actuellement en vigueur. Les classements NF et EPEBAT son également attribués à la plupart de nos mélangeurs dont la liste peut être communiquée sur demande.

GARANTIA

Todos nuestros productos están hechos en manera profesional y se someten a controles escrupulosos en cada etapa del proceso de producción; la robustez legendaria y la fiabilidad que los caracteriza nos permite ofrecer una garantía, válida desde la fecha de instalación:

- Garantía de por vida en todos los cuerpos construidos en bronce
- 5 años de garantía en todos nuestros productos en acabado cromo y los elementos en la superficie de grifería en otro acabado
- 2 años de garantía sobre las partes visibles de las series con acabado en níquel, cobre protegido, plata y oro.

En conformidad con la normativa europea, ejecutado por una ley italiana, la garantía cubre cualquier defecto de fabricación (defectos de fusión, de mecanizado y acabado) después que nuestra Oficina Técnica controle la parte defectuosa.

La garantía no cubre el material que tiene las siguientes situaciones:

- El desgaste normal o daños causados por el exceso de calcio en el agua (juntas, aireador, fondos de alcachofas de ducha, etc.) o debido al hielo
- deterioro de las superficies debido al uso de materiales inadecuados de limpieza o incorrecta limpieza de las superficies sin tener en cuenta nuestras instrucciones
- Los daños causados por una instalación incorrecta
- utilización inusual de los grifos
- Reparación y / o mantenimiento mal hechos y / o el uso de piezas de repuesto inadecuadas o no originales Stella

La garantía se limita a la reparación o al reemplazo de piezas defectuosas, que se realizará en nuestra fábrica o centros de servicio autorizados por nosotros, y no cubre los gastos de extracción, sustitución o cualquier daño a las capas o a los sanitarios.

QUEJAS

Quejas de cualquier tipo deben ser enviadas por correo certificado dentro de los 8 días de llegada a destino de los productos.

CONTROVERSIAS

Para cada controversia se reconoce la competencia exclusiva del Tribunal de Novara.



Rubinetterie Stella S.p.A.

Sede legale

Via Brunelli Maioni, 44
28021 Borgomanero (NO)

Produzione

S.S. 229 km.19+600
28019 Suno (NO)

TEL: (+39) 0321 473351

FAX: (+39) 0321 474231

e-mail: info@rubinetteriestella.it

www.rubinetteriestella.it